

# LTE Multimedia Broadcast Multicast Services (MBMS)

LTE is the technology of choice for mobile operators because it delivers significantly higher bandwidth with the lowest amount of spectral resources.

Data was the initial service supported by LTE networks. By shifting data services from 3G networks to LTE, mobile operators could release 3G resources for voice and satisfy, to some extent, the increasing demand for bandwidth from its customers. The natural evolution of LTE is to provide additional benefits, for the mobile operator to better utilize spectral resources, and for customers to get a better experience at a lower cost.

This is the case with MBMS that deliver content to multiple users simultaneously with a fraction of the resources required by normal data services. Economies of scale will yield a greater value to mobile users who will be able to receive rich content, such as video, at a fraction of the cost.

For example, during major sporting events and concerts, instead of a single mobile user receiving related video services at a very high premium and using dedicated resources, LTE MBMS will be able to provide the same video services to multiple users at a much lower cost per user and using the same amount of resources.



Figure 1. Indianapolis 500 car racing unicast (PDSCH) and broadcast (PMCH) services

## Architecture

MBMS are delivered by the collaboration of four main network components:

Broadcast multicast service center (BMSC) — located at the core of the network, managing the interface with content providers including billing and the content to be transmitted over the wireless network

- MBMS gateway (MBMS-GW) — a logical element that delivers MBMS traffic using IP-multicast reaching multiple cell sites in a single transmission
- Multi-cell/multicast coordination entity (MCE) responsible for the administration of radio resources for MBMS to all radios that are part of the MBMS service area
- The mobility management entity (MME) which performs the MBMS session control signaling including session start, update, and stop, as well as delivering additional MBMS information to the MCE including QoS and MBMS service area

MBMS provides broadcast multimedia services through the LTE network combining unicast (PDSCH) and multicast (PMCH) services in the same LTE frame.

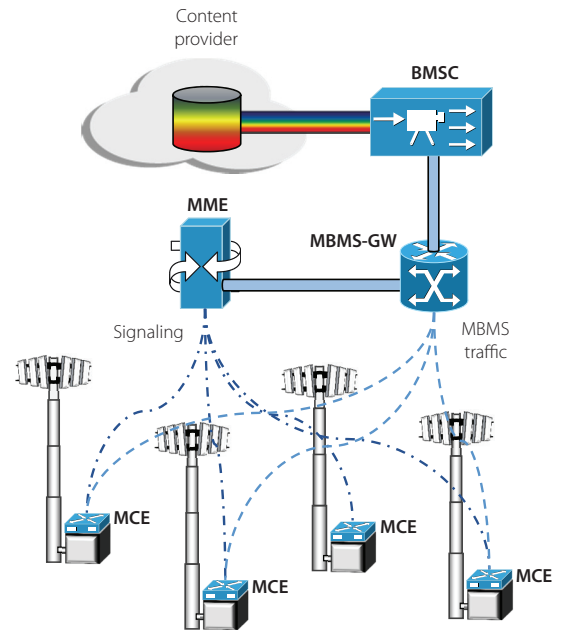

Figure 2. MBMS network architecture



Figure 3. Unicast (PDSCH) and broadcast (PMCH) transmissions

LTE-MBMS radiates the same content to multiple users located within a predefined MBMS service area, allowing all the users subscribed to MBMS to simultaneously receive the same multimedia content.

## Delivery

Transmissions from all the sectors of the MBMS service area are time synchronized and transmitted over the same frequency in the network, also referred as single frequency network (SFN), therefore the resulting MBMS-SFN signal is received from users as if the signal would be transmitted for a single point.

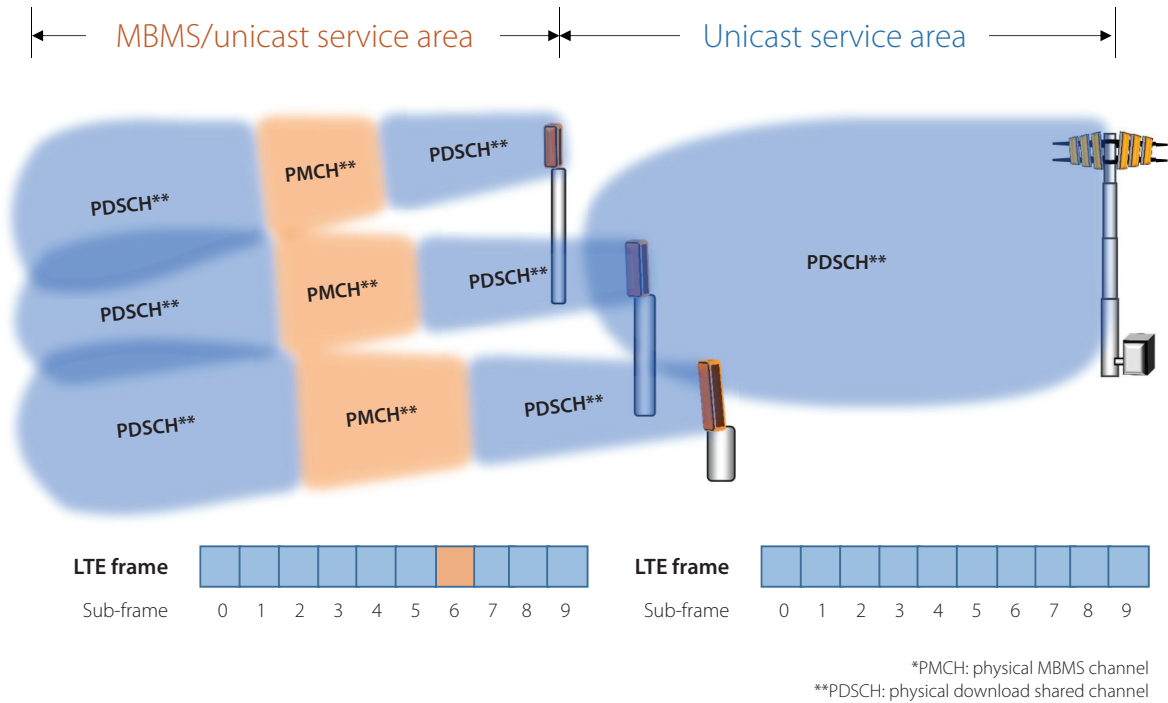

Figure 4. MBMS service areas

This MSFN synchronization area is defined by 3GPP as an area of the network where all radios are synchronized and capable of supporting one or multiple MBSFN areas, over the same carrier; however, each radio can only serve one MBSFN synchronization area.

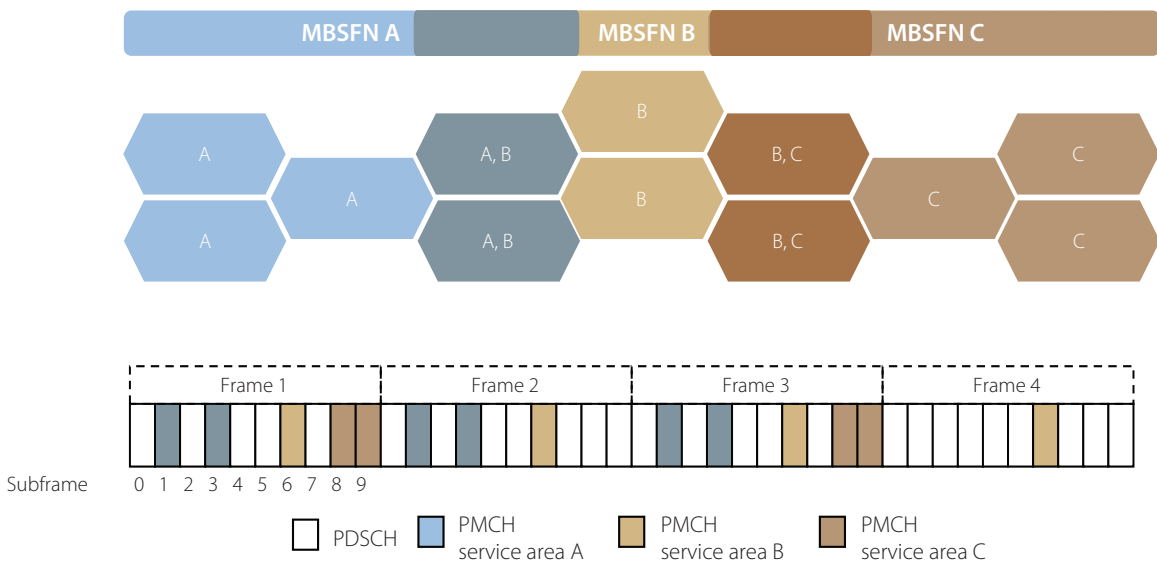

Figure 5. MBMS service areas

The multicast channels within the same MBSFN area occupy a pattern of LTE sub-frames, not necessarily adjacent in time, indicated by the common subframe allocation (CSA) pattern that is periodically repeated.

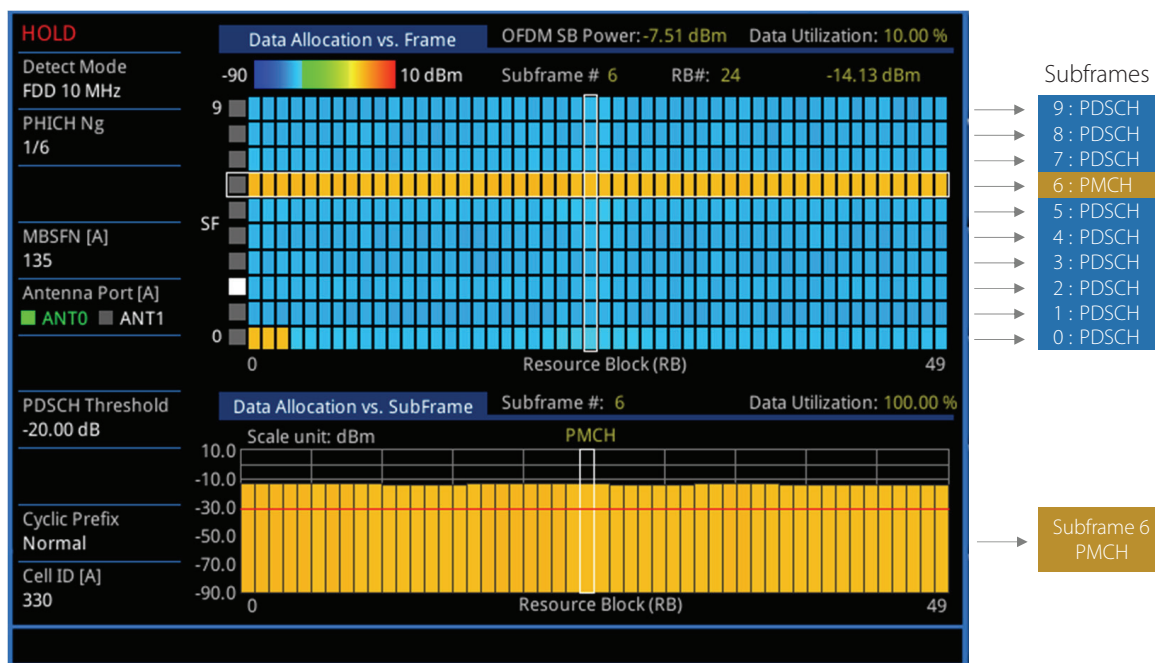

Figure 6. CellAdvisor™ LTE frame analysis — unicast (PDSHC) and broadcast (MBMS) allocations

## Performance

MBMS-SFN services are static and do not vary over time. This provides several benefits, including:

- Reduced interference
- Increased diversity

MBMS-SFN is broadcasted by physical multicast channels (PMCH). This provides the following unique characteristics:

- The physical multicast channel can be transmitted in QPSK, 16 QAM, or 64 QAM
- No transmit diversity (MIMO) scheme is specified
- Layer mapping and pre-coding shall be done assuming a single antenna port and the transmission shall use antenna port 4
- The PMCH can only be transmitted in the MBSFN region of an MBSFN sub-frame
- The PMCH shall use extended cyclic prefix
- The PMCH schedule cannot be dynamically adjusted by the radio

In the following example, MBMS data is transmitted over service area MSFN 135 on LTE sub-frame 6 and data is transmitted in QPSK modulation scheme.

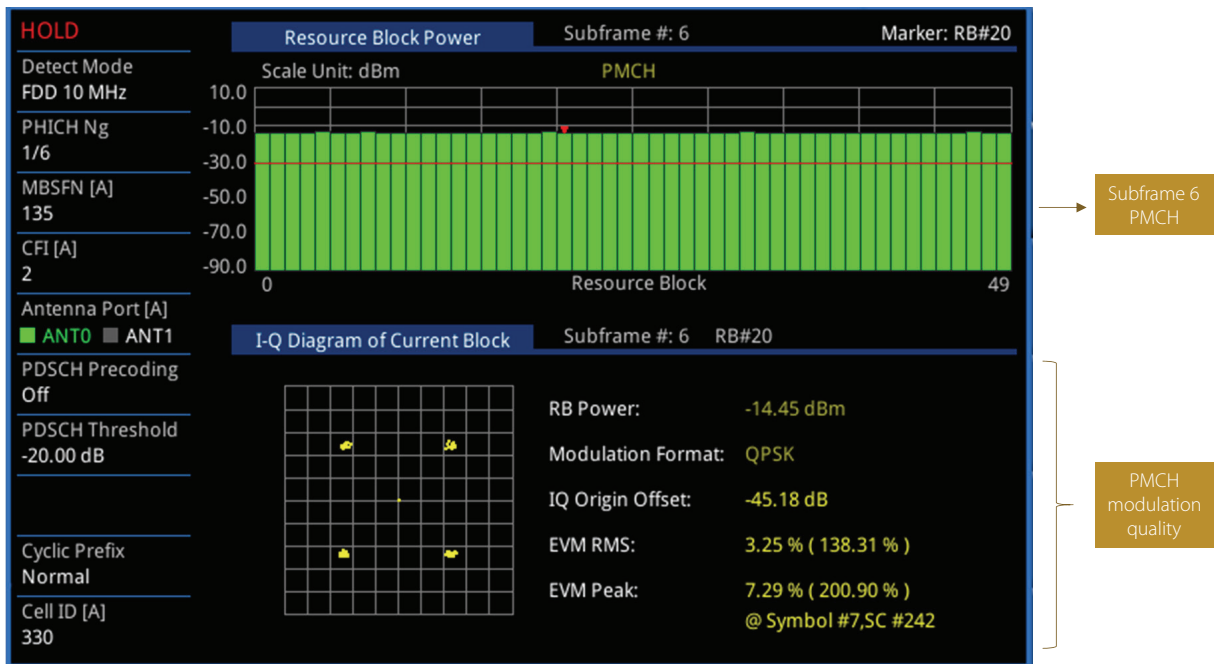

Figure 7. CellAdvisor broadcast (MBMS) modulation quality

Modulation quality is measured as the level of distortion on the modulated symbols by a metric defined by the standards as error vector magnitude (EVM), which measures the amount of error or distortion the symbols are experiencing at the user device from the ideal position.

The modulation quality exhibited by MBMS data has a direct relationship with the service quality received by users. A high modulation quality or low EVM from PMCH data will deliver high-quality content, and conversely a low modulation quality or high EVM from PMCH data will deliver poor-quality content.

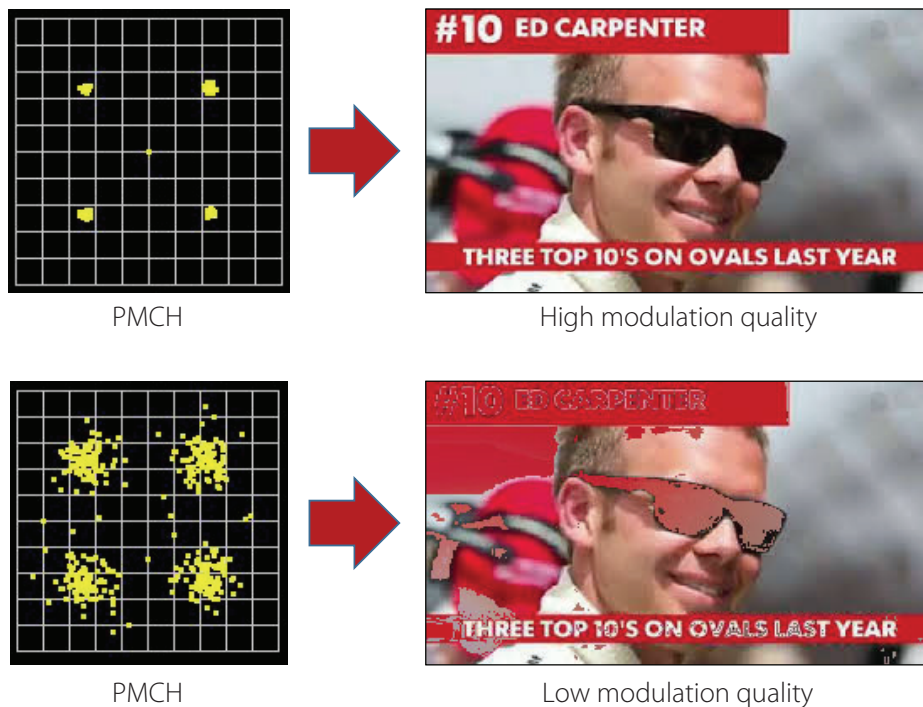

Figure 8. Broadcast (MBMS) modulation quality

The PMCH contains the following logical channels:

- Multicast traffic channels (MTCH) — transporting multimedia content
- Multicast control channels (MCCH) — transporting control content such as MBMS sub-frame allocation and modulation scheme for mobile users to properly receive the multimedia content

Since the MBMS transmission serves multiple mobile devices, there is no feedback such as hybrid ARQ and MIMO is not supported. Therefore, the common control pilot signals or reference signals are not delivered as RS0 or RS1 for MIMO 2x, since MIMO is not supported; but logically, the MBMS pilot signal or MBSFN-RS is delivered, per 3GPP, as if it was on antenna 4.

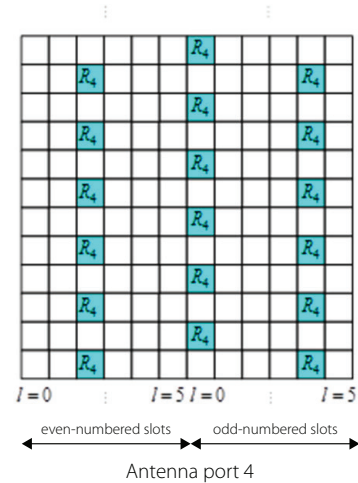

Figure 9. MBMS-SFM reference signal

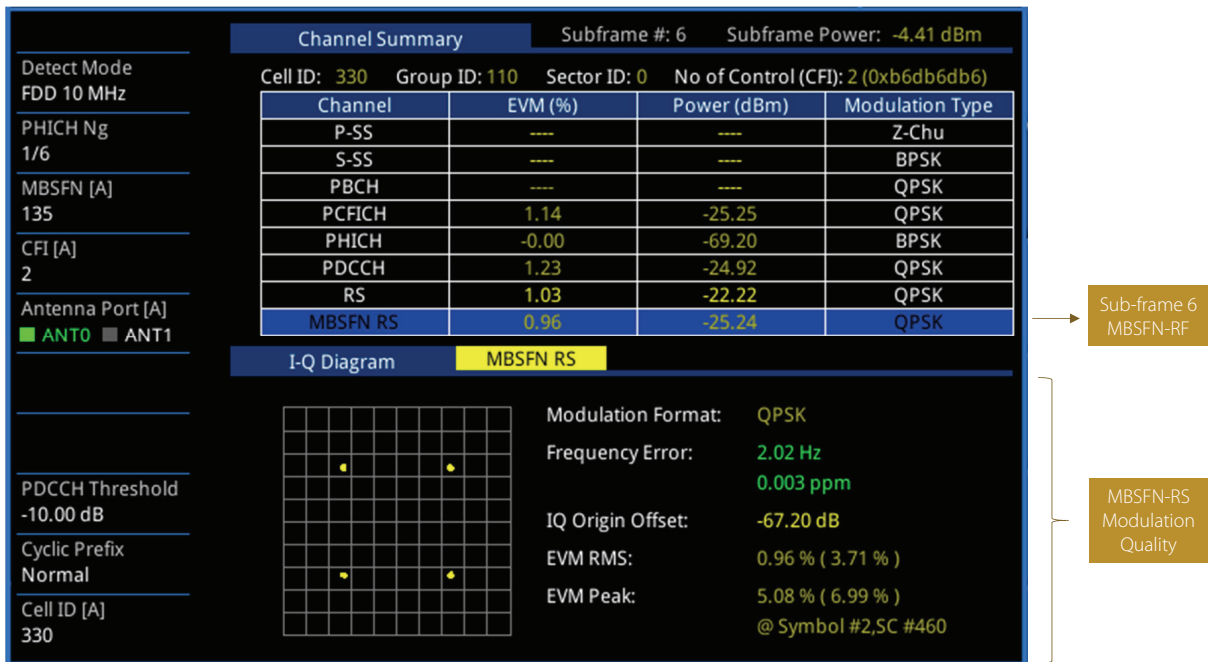

Figure 10. CellAdvisor MBMB SFN reference signal (MBSFN RS)

Proper delivery of MBMS relies on the ability to synchronize the transmission from all the sectors in the MSFN service area in order to create a constructive interference; therefore, it is particularly important to maintain low time alignment error (TAE) among the transmitting sectors.

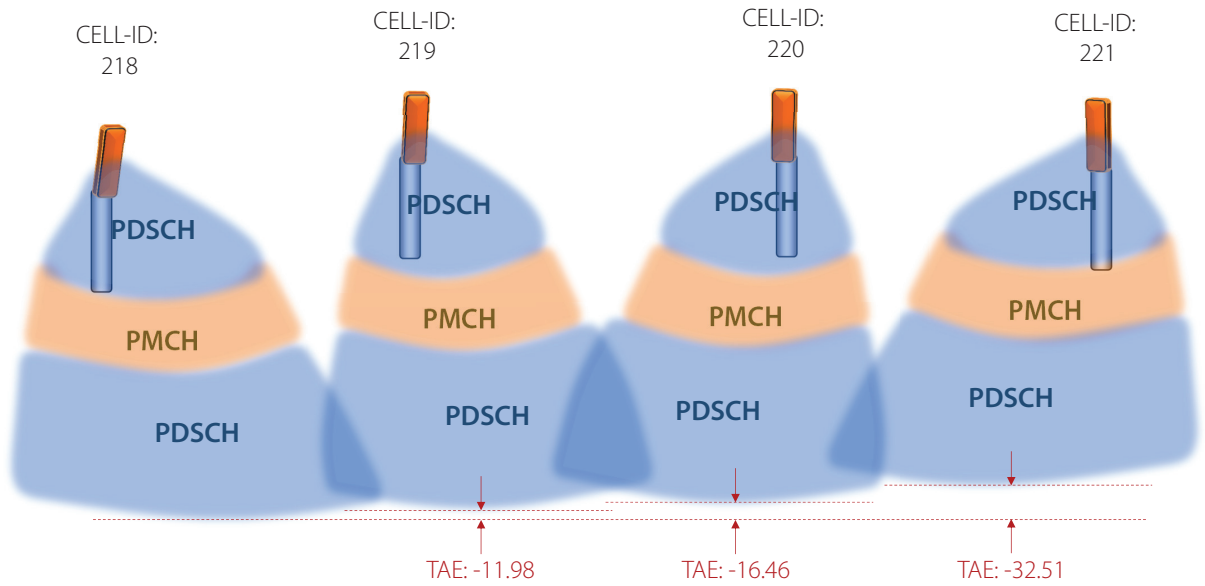

Figure 11. Multi-sector TAE

The following is a measurement technique where the sector identities or physical cell identities (PCI) are set accordingly to the service radios and TAE measurements are performed in unicast traffic (PDSCH) which each sector transmits its own reference signal.

The synchronization of the sectors is measured in terms of time alignment error (TAE) with the first PCI as a reference.

Subframe #: 0	CC1 3350 Fwd	CC2 3350 Fwd	CC3 3350 Fwd	CC4 3350 Fwd	CC1	CC2	CC3	CC4
<b>Power (dBm)</b>								
P-SS	-82.49	-82.21	-82.63	-82.84				
S-SS	-82.14	-81.93	-82.21	-82.51				
PBCH	-84.20	-84.77	-84.48	-84.63				
PCFICH	-87.94	-87.59	-85.03	-88.26				
RS0	-88.11	-87.81	-87.76	-88.29				
RS1	-88.86	-88.32	-88.47	-88.93				
<b>EVM (%)</b>								
P-SS	45.37	47.94	48.98	46.50				
S-SS	53.99	56.63	57.15	53.24				
PBCH	48.26	48.05	48.82	50.20				
PCFICH	50.62	49.33	41.84	49.04				
RS0	18.95	19.30	17.42	21.52				
RS1	20.44	22.50	17.86	24.53				
Cell ID	218	219	220	221				
Frequency Error	-36.59 Hz	43.62 Hz	-40.05 Hz	81.41 Hz				
TAE	0.00 ns	-11.98 ns	-16.46 ns	-32.51 ns				
Antenna Port	ANT0	ANT1	ANT0	ANT1				

Inter-sector time alignment error

Figure 12. CellAdvisor multi-sector TAE

## Assessment

The Viavi CellAdvisor tests LTE MBMS from radios enabled with LTE MBMS, verifying the proper allocation of physical MBMS channels (PMCH) and physical shared data channels (PDSCH) in the LTE signal.

As well as the signal analysis, CellAdvisor performs over-the-air analysis from a cluster of sectors assessing the signal quality, time alignment error, and modulation level delivered on MBMS, ultimately ensuring the proper delivery of rich services to its mobile users.

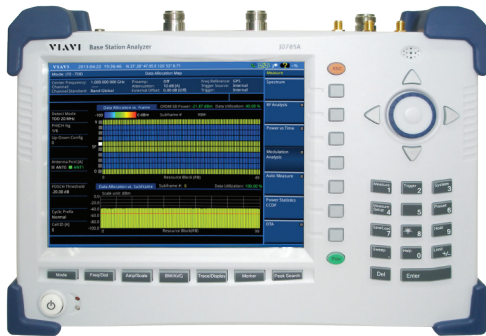

Figure 13. CellAdvisor

## References

- 3GPP 23.246 Technical Specification Group Services and System Aspects; Multimedia Broadcast/Multicast Service (MBMS); Architecture and Functional Description
- 3GPP 36.211 Technical Specification Group Radio Access Network; Evolved Universal Terrestrial Radio Access (E-UTRA); Physical Channels and Modulation
- 3GPP 36.300 Technical Specification Group Radio Access Network; Evolved Universal Terrestrial Radio Access (E-UTRA) and Evolved Universal Terrestrial Radio Access Network (E-UTRAN); Overall Description; Stage 2



Contact Us **+1 844 GO VIAVI**  
(+1 844 468 4284)

To reach the Viavi office nearest you,  
visit [viavisolutions.com/contacts](http://viavisolutions.com/contacts).

© 2015 Viavi Solutions Inc.  
Product specifications and descriptions in this  
document are subject to change without notice.  
ltembms-ds-nsd-nse-ae  
30175943 900 0814